

PO286 00 Scale Ramshackle Workshop INSTRUCTIONS

PLEASE

Read through the instructions and familiarise yourself with the kit components before you start any building.

Kit components.

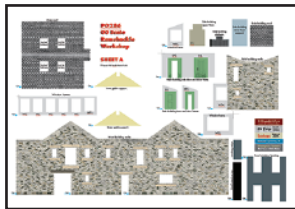

SHEET A.

Printed components to make the main building.

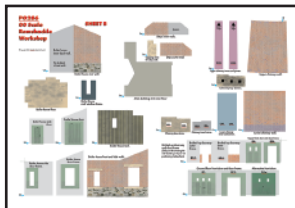

SHEET B.

Printed components for chimney, boiler house and various doors etc.

GREY SHEET C.

Thick grey card with inner strengthening components.

KEY to components:

- G1** Inner ground floor I.
- G2** Inner ground floor II.
- G3** Inner 1st. floor with tab.
- G4** Ridge beam.
- G5** Boiler house back wall.
- G6** Boiler house steps (5 sets).

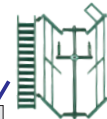
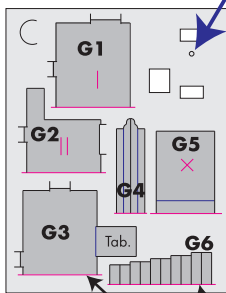

PLASTIC STEPS

Attached to the grey card.

Lines indicated here in red are the cut lines to extract components from base sheet.

PO286 00 Scale Ramshackle Workshop Glazing sheet

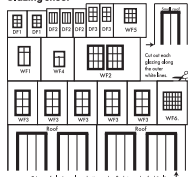

GLAZING SHEET.

Clear plastic glazing to fit behind the window frame openings.

INSTRUCTION BOOKLET (this one)

1 Tools to build this kit.

To build this kit you will need a few basic tools:

1. A modellers knife.
2. A cutting surface - A cutting mat or a sheet of thick card will do.
3. A sharp pair of scissors
4. A steel ruler.
5. Fine point tweezers.
6. Something to clamp surfaces together, Bulldog clips are good for this job.
6. METCALFE Ultra Fine Tip Glue Bottles (see 3)

2 Glue.

We recommend using a combination of glue: **Speed Bond** is slightly slow drying, ideal for where a little positioning is required as you build.

Rocket Card Glue is an instant and fast drying glue, great for where you need stuff to stay just where you place it. Supplied with its own fine tip applicator.

Both made by Deluxe Materials - deluxematerials.com

Also **UHU** All Purpose solvent free.

This is the best glue for fixing the plastic glazing to the window frames.



Plastic Kit Glue by Deluxe Materials.

You will need this or similar to build the plastic steps

3 Ultra Fine Tip Glue Applicators.

An absolute 'must' when building this kit. When used with **Speed Bond** or **UHU** perfect amounts of glue can be applied to very precise areas without any mess.



Speed Bond in an applicator was used to build most of this kit. UHU for fixing the glazing.

A METCALFE product supplied in packs of 3
Product code MT907
Glue not included

4 Extracting components from base sheets.

To stop the components falling off the base sheets, they are held secure with score lines (marked with blue arrows) that cut about 75% of the way through the card.

To release them run the point of your knife along these score lines and they will come seamlessly away. **WARNING**, Cut with care to reduce the risk of the blade running out of the score and cutting the component.

5 Make your builders yard.

As you extract the components from the base sheets they need to be kept away from your working area on a thick piece of card or a tray until needed.



Example of builders yard.

Extract all the components from all three sheets and place neatly in your builders yard as shown above.

DON'T throw away the waste card bits yet, you will need them for minor patching and strengthening later.

6 The Windows.

Each window opening has a corresponding window frame, so before any other work is done it is best to get all the glazing pieces attached to the backs of each frame.

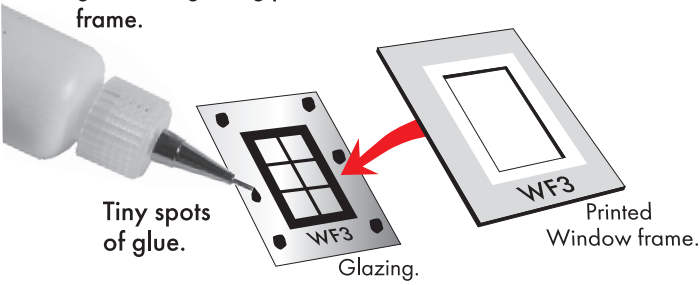

Tiny spots of glue.

Glazing.

Printed Window frame.

Using a fine tip applicator, place tiny spot of **UHU** glue on the edges of the glazing and then fix the window frame on top.

DOORS.

There are two sets of doors for the main ground floor opening: D1. & D1a. Choose which one you want and fit the glazing.

Note: Glazing DF1. fits door D1a. DF2. fits door D1. and DF3. fits door D4. (It is obvious which goes where!).

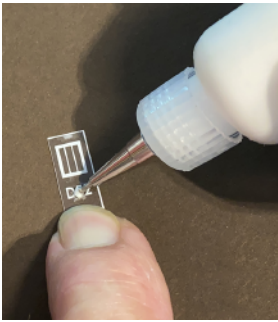

Hold glazing down with a finger nail and place tiny spots of glue, top and bottom.

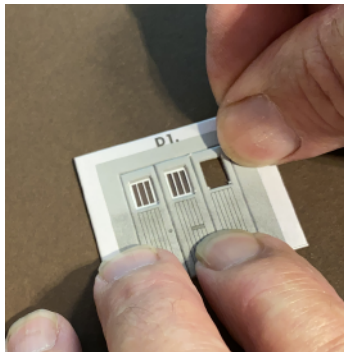

Place window opening directly on top centre the glazing. Press firmly down to fix.

ROOF WINDOWS.

The roof glazings are slightly larger than the window leading. Attach as shown with edges sticking out. Leave to fully dry before trimming the overhanging edges flush to the frame edge.

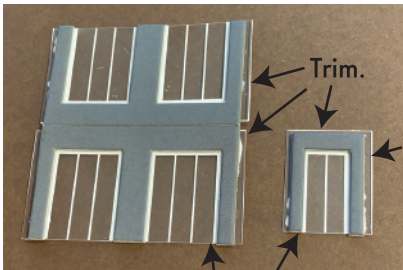

Line up bottom edges flush to frame.

Place all window frames with glazing back into your builders yard until needed.

Note: BD1. & BD2. alternative bricked up doorway (glazing WF6. fits window opening) is only to be used to fit into upper doorway if you are positioning the side building and stairs in a different position.

7 The Main Building.

Start by fitting all the windows. Don't fit the doors.

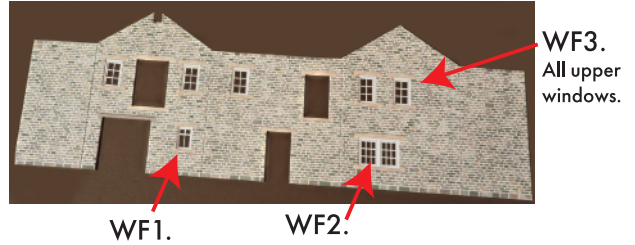

Inner Floor.

This is made up by first fixing Grey card G2. on top of G1.

With the 3rd. floor fixed on top.

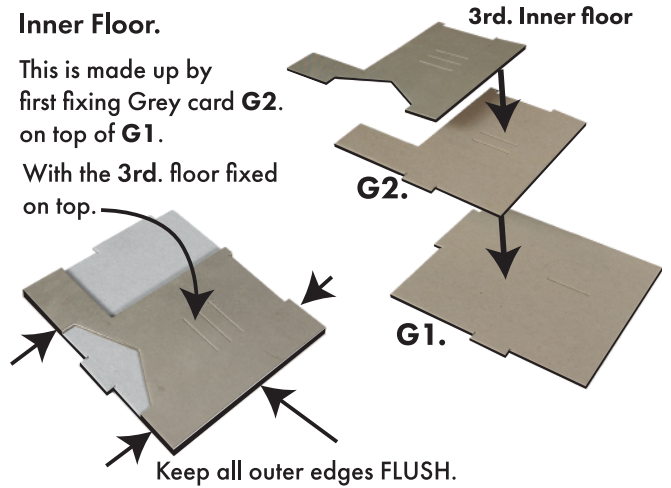

Fix walls to base.

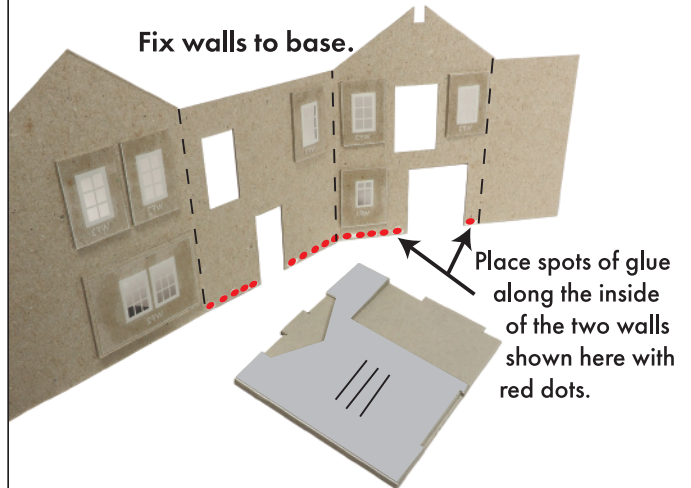

Then fix the walls to the edges of the base card with door steps pushed through the openings.

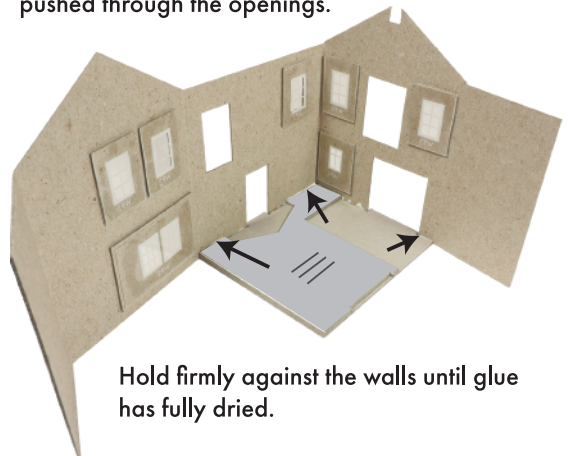

Hold firmly against the walls until glue has fully dried.

Fix Doors to Door Frames.

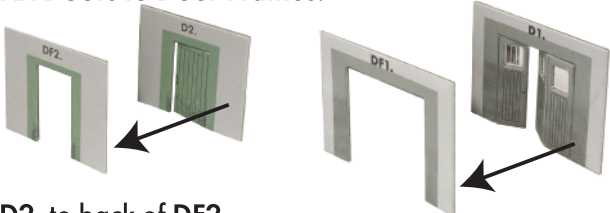

D2. to back of DF2.

D1. to back of DF1.

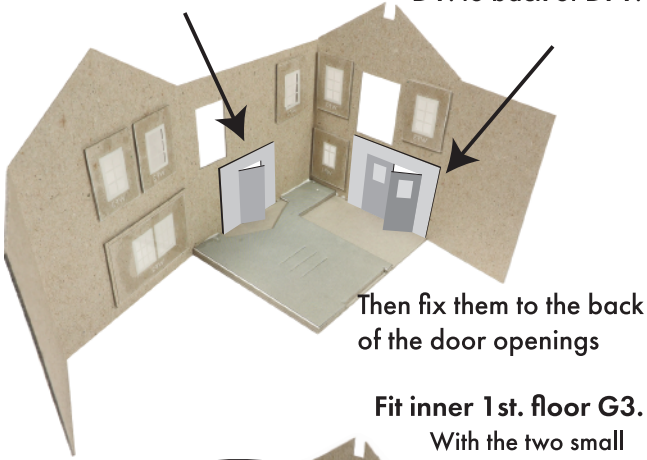

Then fix them to the back of the door openings

Fit inner 1st. floor G3.

With the two small door sills sitting on top of the door openings.

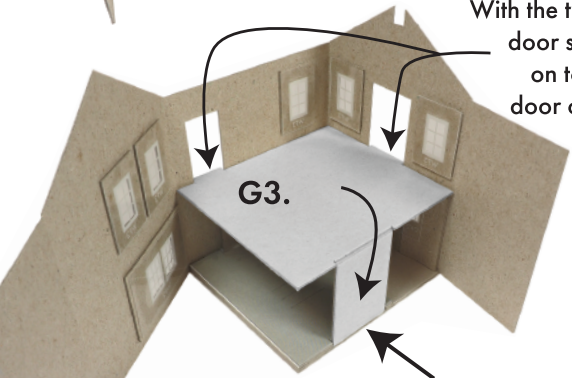

G3.

Fold down the tab and fix the end into the slot on the edge of the base card.

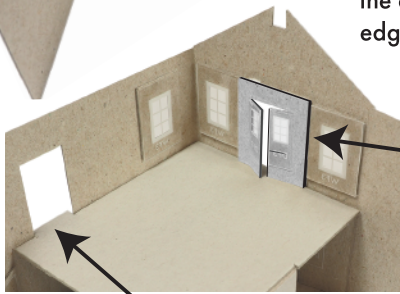

Fit upper door D4 to frame DF4. and fix to back of door opening.

Only fit bricked up door BD1. and BD2. to this opening if you are not attaching the side building.

Fold the outer walls around and fix butt ended together where they meet to the grey inner tab.

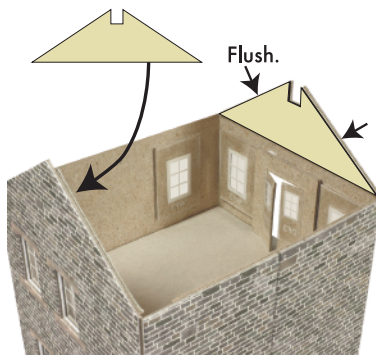
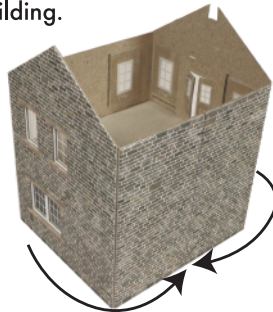

Flush.

Fix the two inner gable supports to the inside of the walls with top edges lined up flush.

Assemble the Ridge Beam.

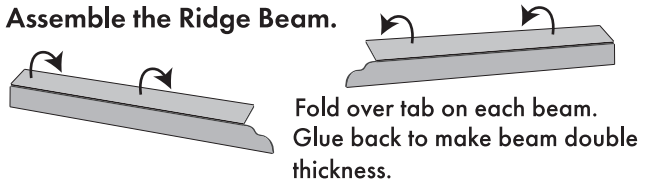

Fold over tab on each beam. Glue back to make beam double thickness.

Glue two beams together

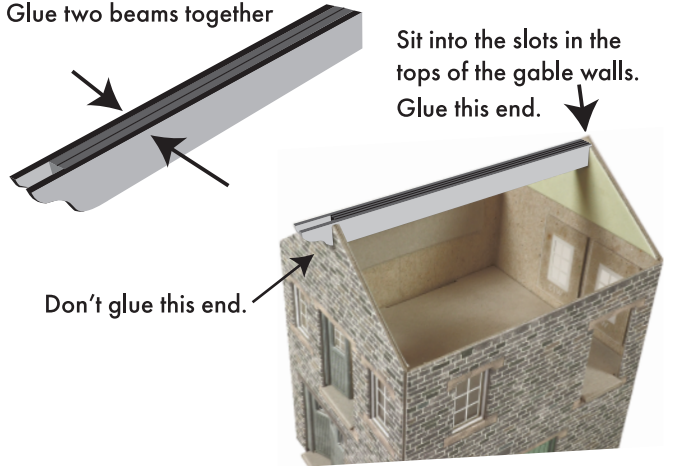

Sit into the slots in the tops of the gable walls. Glue this end.

Don't glue this end.

The Roof.



Fold the four tabs in the window openings back and glue to underside of roof.

Sit roof on top of the walls with the four tabs underneath fitting against the gable walls at either end.



The roof window straddles the roof. Fix down with tiny spots of glue around the edges of the window openings

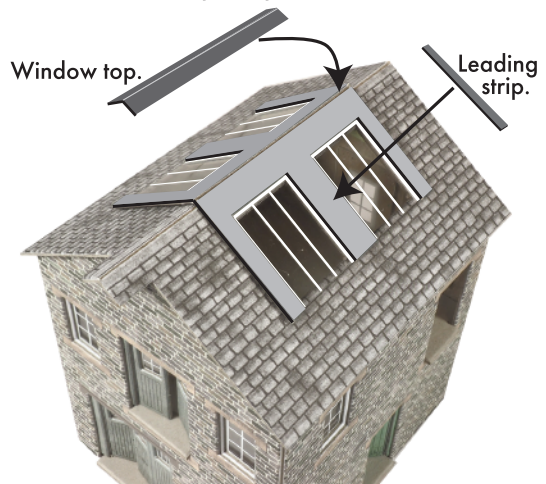

Window top.

Leading strip.

8 The Side Building.

Fix the two windows to the openings.

Keep them both flush with the wall edges.

WF4.

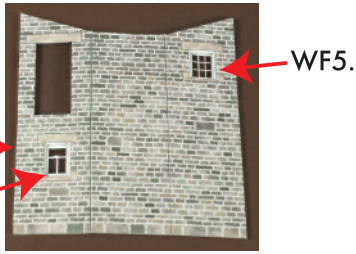

Fit the blue inner support

Flush to side.

Flush to base.

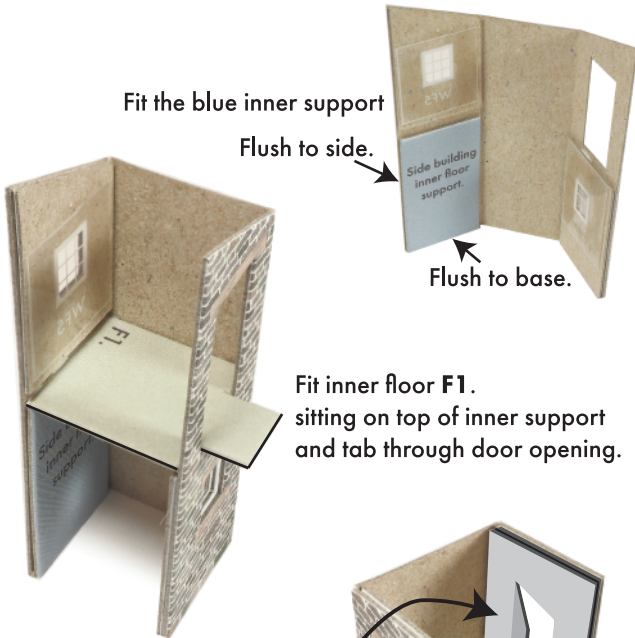

Fit inner floor **F1**.
sitting on top of inner support
and tab through door opening.

Fit door **D3**. to door frame **DF3**.
Then fix to back of door opening.

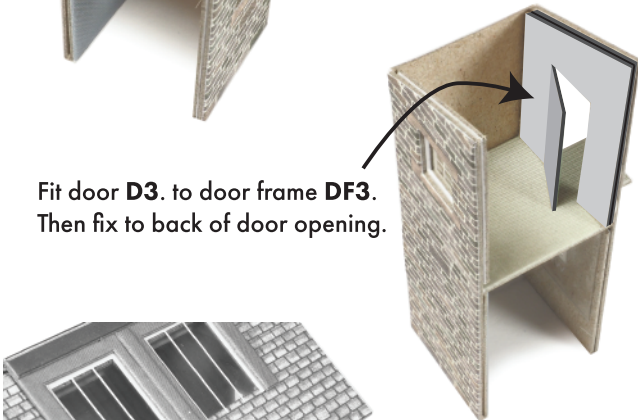

Attach the side building
to the side wall of the
main building.

Then fit the roof.



Sit the small platform
on top of the tab that
sticks out through the
doorway.

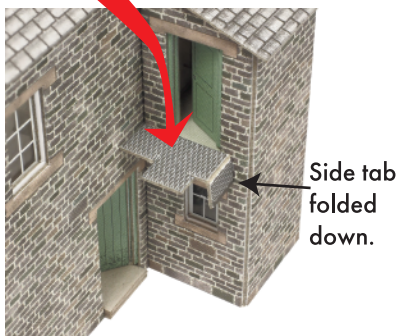

Side tab
folded
down.

9 The Boiler House.

Fix the two boiler house door frames to the inside of the
front and side walls.

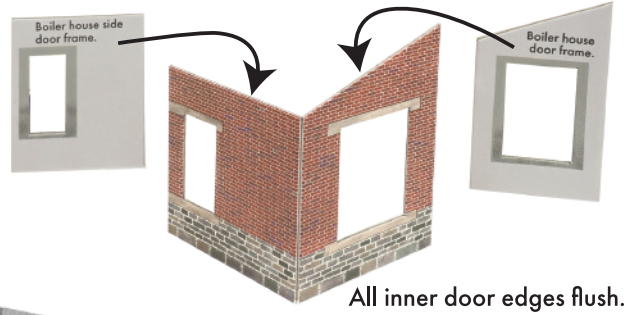

All inner door edges flush.

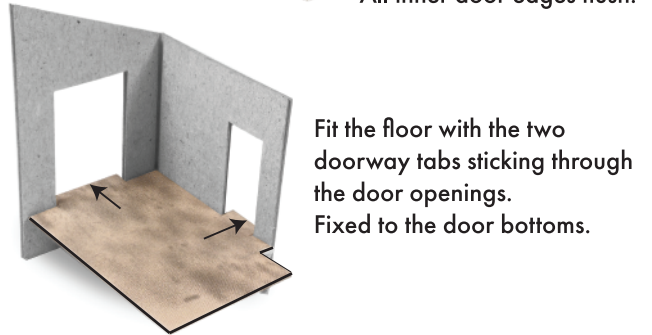

Fit the floor with the two
doorway tabs sticking through
the door openings.
Fixed to the door bottoms.

Fit the two boiler house doors.

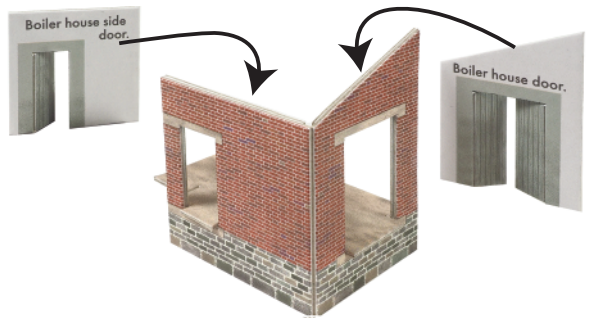

The double door
fits so there is a recess
down this wall.

Grey card
G5.

Fold up small
tab along base
and glue.

Then fix to side of building
with tab along bottom edge.

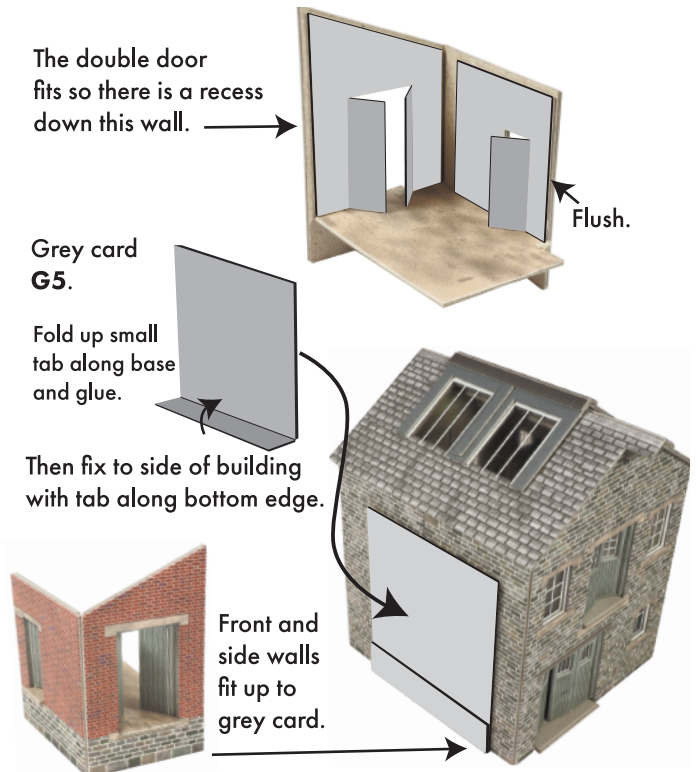

Front and side walls
fit up to
grey card.

Like this with the floor sitting directly on top of the long tab.

The front wall fits against the side of the grey card G3.

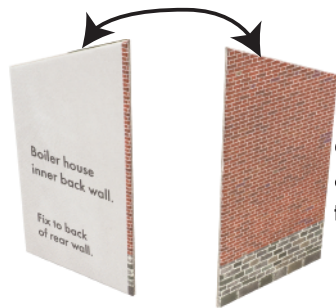
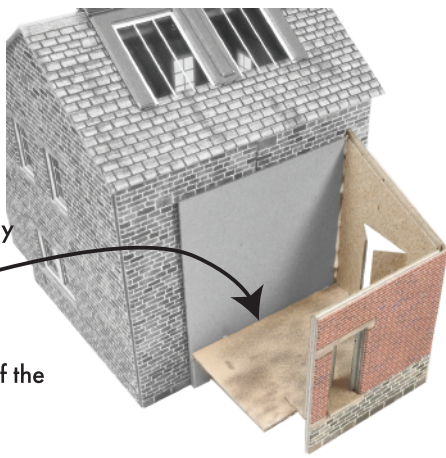

Glue the two sections of the rear wall back to back to make double thickness.

Then fix to the edge of the grey card and floor as shown.

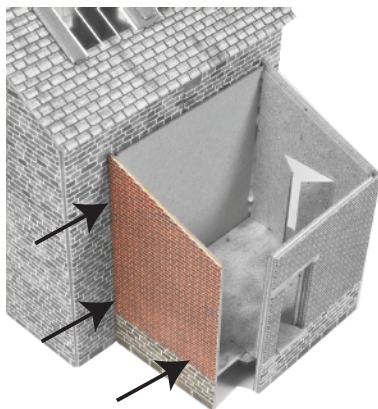

Attach the window to the roof before fitting to the building.

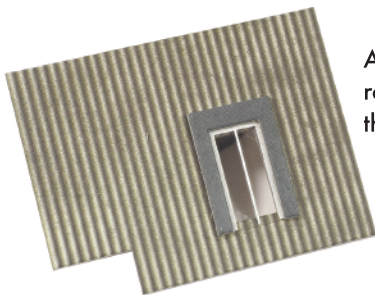

Fit the roof so that the cut away section is flush with the walls.

This is to allow the chimney to fit into the recess later.

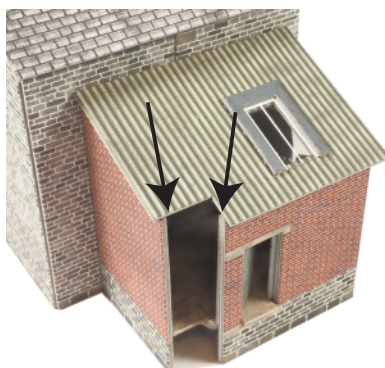

10 The Chimney.

Start with the base section (that's the one with the blue brick around the base)

Bend the four score lines. Then attach the two CH1. long grey inner joiners.

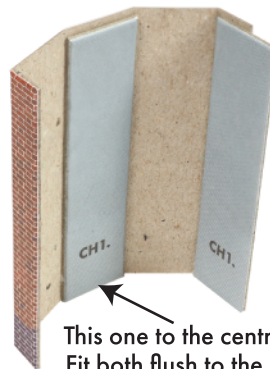

This one to the centre section. Fit both flush to the base.

This one to the end section so it overhangs.

Leave to fully dry before you fold the walls around and fix the opposite end to the overhanging joiner tab.

When fast, drop the small square brace IBL. down inside the chimney sitting on top of the two grey inner joiners.

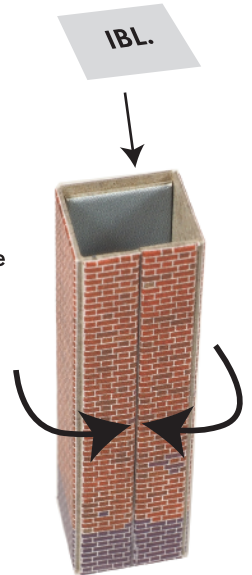

HINT:

Use clothes pegs to hold chimney together as the glue dries.

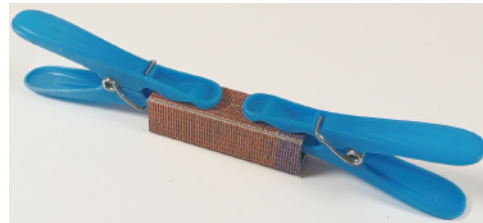

Fit the two chimney base cards CB1. & CB2.

On top of the chimney like this, overhanging equally on all edges.

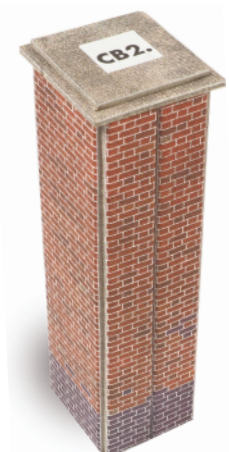

Now for the top section.

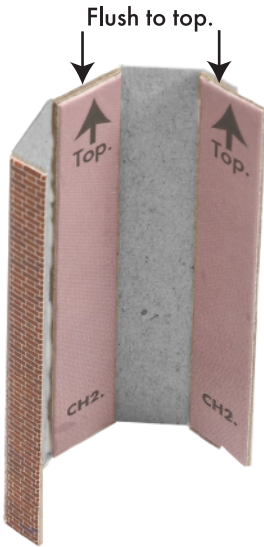

NOTE:

This chimney is slightly tapered
The top is the narrow end.

The two inner joiners **CH2.**
fit in the same way as with
the base section **EXCEPT**
fit them flush to the top
edge of the chimney.

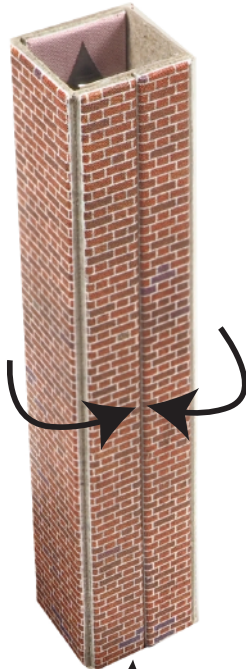

Fold wall around and
fix to joiner.

When fast, fit the small
inner brace **IBU.** into
the base of the chimney
sitting on the two inner
pink joiners.

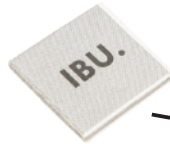

Fix the three
chimney top stones
one on top of the other.

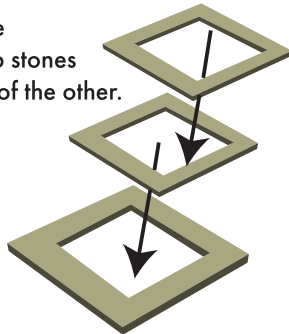

Aligning the centre holes.
Then fit to chimney top.

Overhanging equally
on all four sides.

REMEMBER:

At each stage, let the glue dry
before moving on to the next part.
A little patience, and you won't
have bits falling apart as you build.

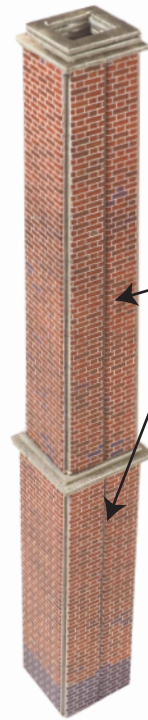
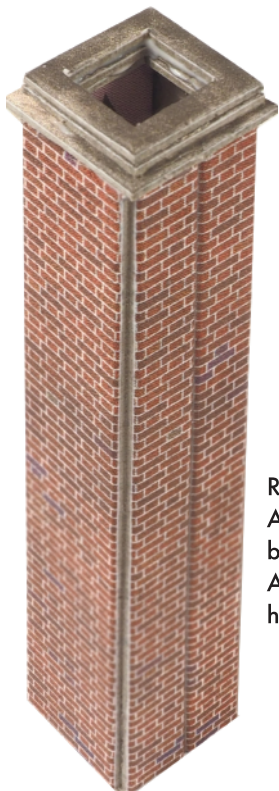

Fit the top section of
the chimney to the bottom
like this.

Keep the joints on the same
side and when you fit the
stack to the building as shown
below, face the join in towards
the building, so it doesn't
show as much.

A piece of wire to fashion a
lightening conductor would
also hide it.



11 Steps to the Boiler House.

There are five steps. Each step made up of two pieces of grey card laid on top of one another.

G6. on Grey card

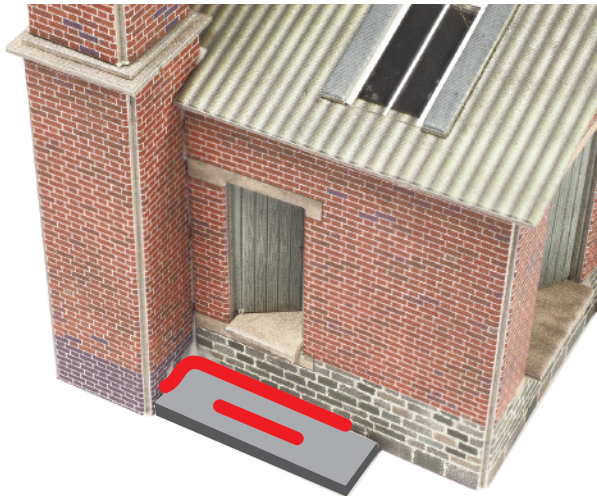
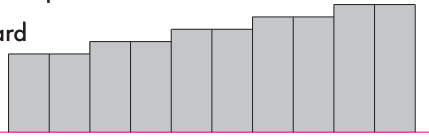

Starting with the longest card place it into the corner as shown here and then with your fine tip glue applicator, squirt a strip of glue along the edge of the card, plus a little on the centre of the step, as shown in red.

Place the second long card directly on top and push into the corner. Then place a little glue in the same way on that card and affix the next slightly shorter card on top.



Now repeat the process with all the other card steps until they are all neatly stacked up like this. Each step pushed tightly into the corner.

Now for the small wall to fit against the steps.

Glue the three components together.

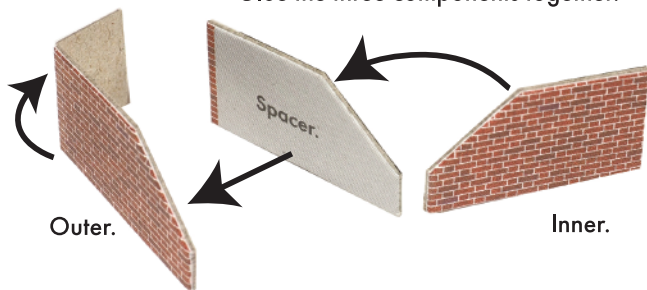

Like this with the small end portion folded around at a right angle.

Now cut this end off, flush with the edge of the inner wall.

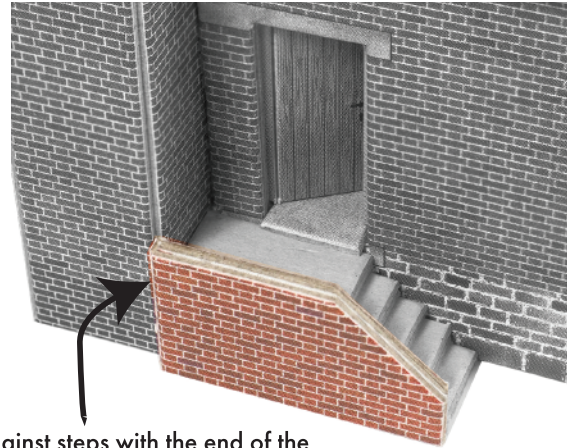
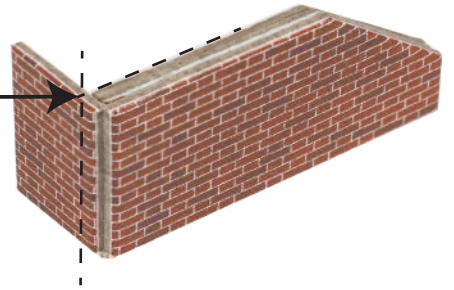

Fix against steps with the end of the wall fitting into the crease in the chimney corner.

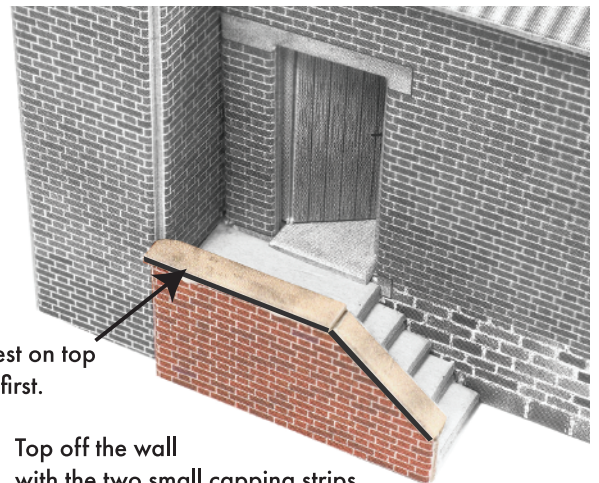

Longest on top fitted first.

Top off the wall with the two small capping strips.

12 Plastic Steps.

You will need special plastic glue for this job as outlined on page 1.

