

**Municipal Building  
INSTRUCTIONS**

**PLEASE - PAY ATTENTION**  
 Read through the instructions and familiarise yourself with the kit before you start any building. Follow these step by step instructions carefully to make this wonderfully detailed kit.

**Kit Components**

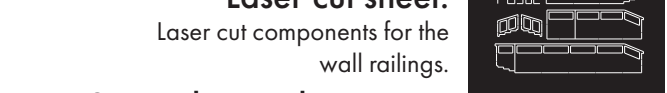
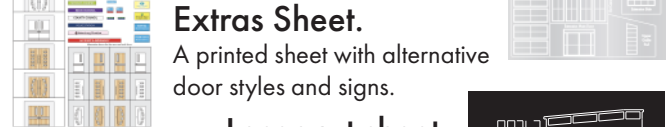
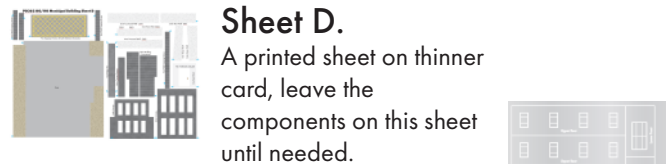
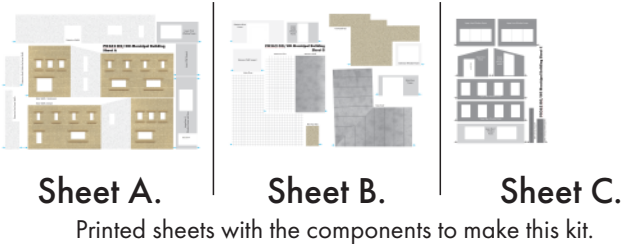

**Two Strengthener sheets.**

A thick grey card with inner and base strengthening parts.

Below is a key to each of parts with an abbreviated code, this code will be referenced in the instructions.

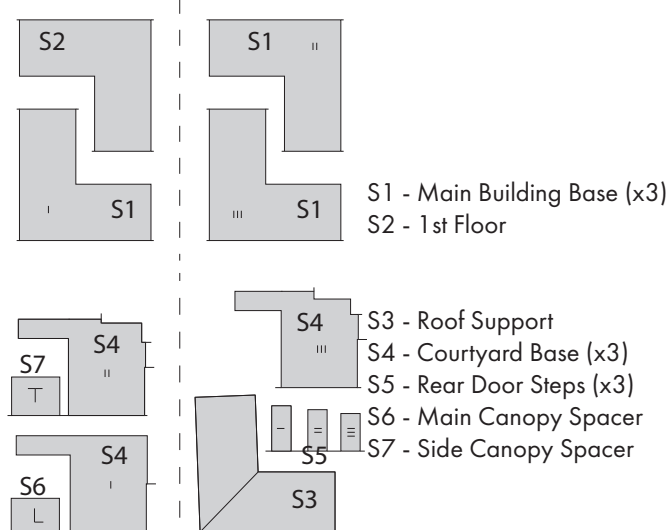

**PRE-BUILD PREPARATIONS**

**Tools you'll need to build this kit**

(all of which are available on our website:  
[www.metcalfe-models.com](http://www.metcalfe-models.com))

1. A modellers knife
2. A cutting mat
3. A steel ruler
4. A pair of fine pointed tweezers
5. Water colour paint set
6. Metcalfe ultra fine tipped glue applicator
7. Glue (see below)

**Glues**

We recommend using a combination of glues, Speed bond and Rokat card glue, both are produced by Deluxe materials.

**Rokat card glue** is an instant, fast drying glue which is great quickly securing components that require little positioning. It also comes with it's own fine tip applicator.

**Speed Bond** is a slightly slower drying glue which is ideal for the components where careful positioning is required.

**UHU solvent free** is also a great all round glue and is excellent for fixing the plastic windows.

**Metcalfe ultra fine tipped glue applicator** is essential for applying small amounts of glue to the smaller components.

These bottles come in a pack of 3 and are best used with Speed Bond and UHU, simply unscrew the top and fill with the glue.



**Extracting the components**

To prevent the components from falling off the sheets they are held secure with scorelines, marked with a These are cuts that only go about 75% of the way through the card. To release them carefully run the point of your knife along these scorelines and they will come seamlessly away, be very careful your blade does not run off the score and damage the components. Use a steel ruler as a guide especially if using a new sharp blade. Keep the components organised and away from your work area on a piece of card or tray that we will call your builders yard.

At this stage only extract the window frames, walls etc. Leave the small components - roof walls, canopy supports and all the parts on sheet D (apart from the courtyard door) on the base sheet so they don't get lost.

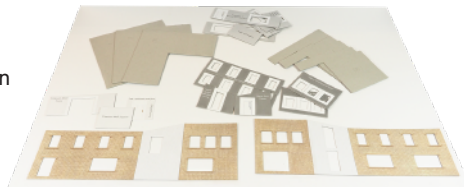

**Windows**

Carefully cut out the windows along the outer white line from the glazing sheet, organise and place on a dark piece of card (so that you can see them and they don't get lost) and place within your builders yard until required.

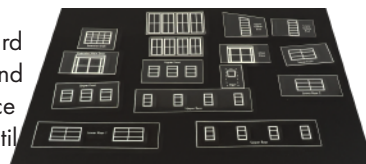

## Painting the exposed edges

The exposed edges, undersides and folds of the roof sections and wall ends will need to be coloured to match the printed surface. Use some water paints, mix the colour with lots and lots of water, test against the leftover bleed on the base sheet to get the correct shade and colour. The card only has to be tinted, as a solid painted line will make it look worse. Quickly wipe away any excess paint off the printed surface before it dries. While not strictly necessary for the thick card components, the thin, dark grey components on Sheet D will need the edges and folds painted.

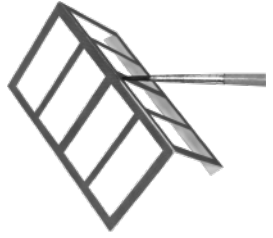

## LET'S START TO BUILD!

### 1 Main Base

Let's start by combining all the base components, so they can be placed under weights to allow time for the glue to set while other parts are constructed.

Combine the 3 S1 strengtheners with the I, II & III marked on them. While it's not important with this base it's best to get into the habit of having I at the bottom and III at the top for the other bases.

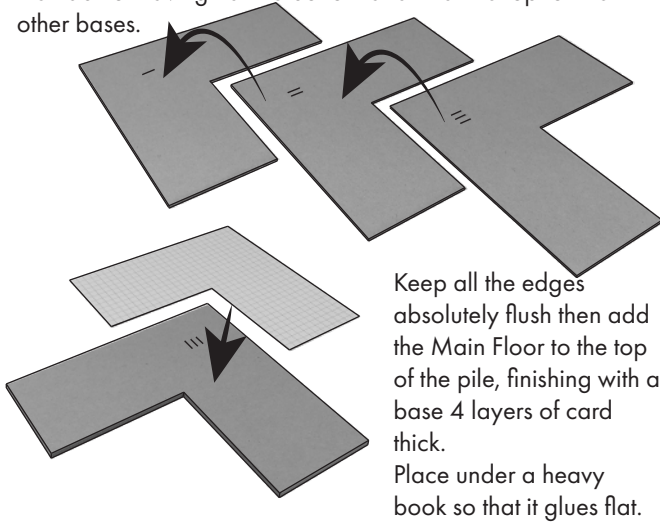

At this stage we may as well combine the other bases so that they can join the main base under the book.

Combine the 3 S4 strengtheners, I at the bottom and III at the top, keep all edges flush noting the steps at the front edges.

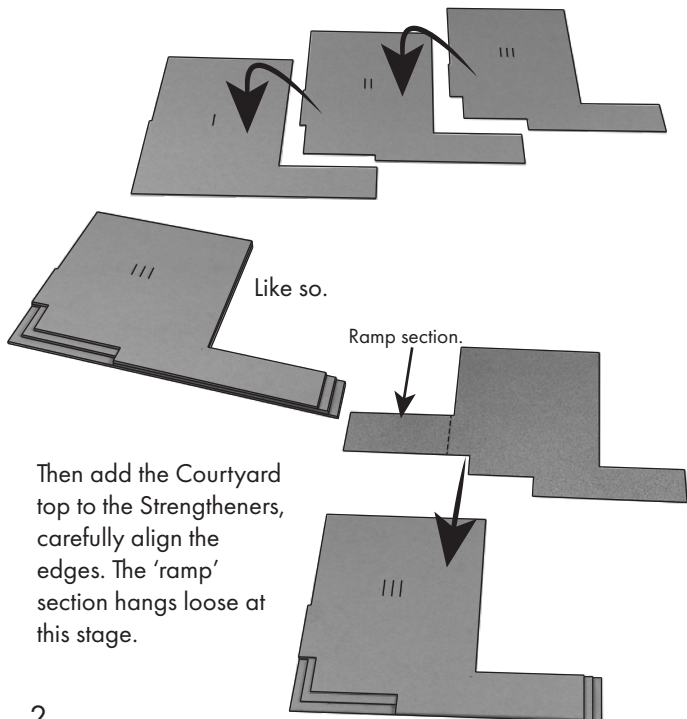

Finally the same with the rear steps Strengtheners S5, again I at the bottom and III at the top, keep the long edges and one short edge flush.

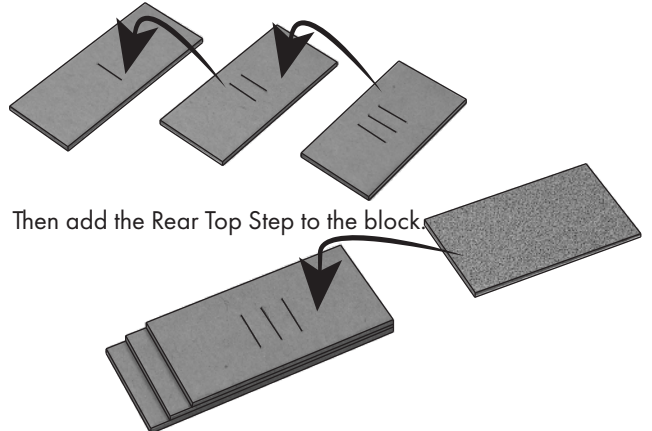

Keep all the completed bases under a heavy book so that they glue flat.

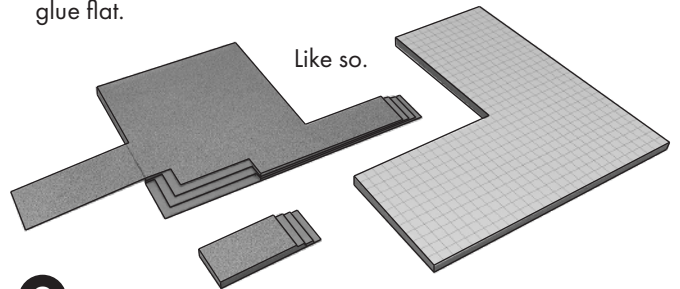

### 2 Window & Door Frames

Match up all the glazing with the corresponding window frames. Carefully position the window so it faces through the opening on the frame. Then place back into the builders yard until needed. Leave the canopy glazing until later. Always check the fit before applying glue, then if any windows don't align just right then trim the glazing.

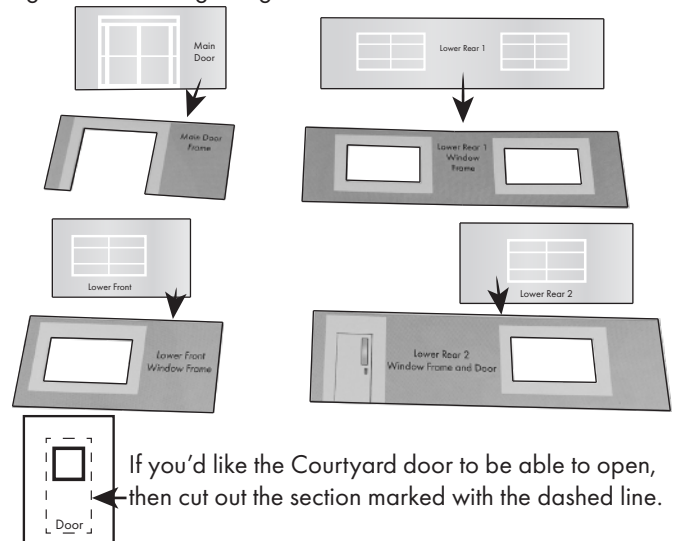

### 3 Main Walls

Start with the right hand wall (with the doorway). Fit tight into the corner of the base then wrap the walls around the base. Make sure that the bottom of the wall is completely flush with the underside of the base, else problems may arise later.

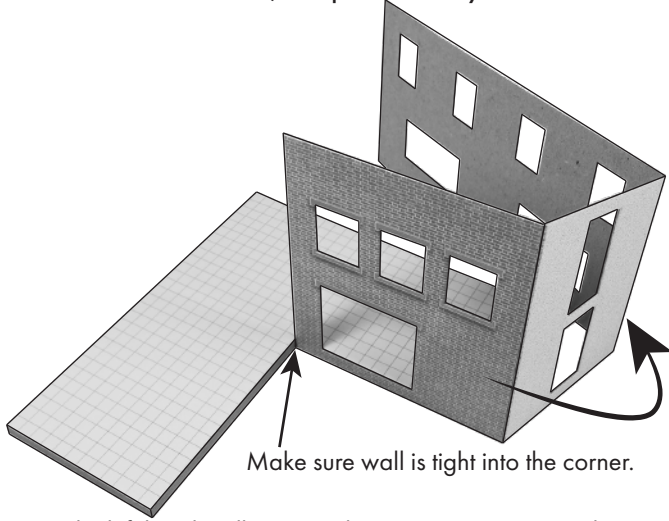

Next the left hand wall, again take great care to ensure the base of the wall is completely flush to the underside of the base.

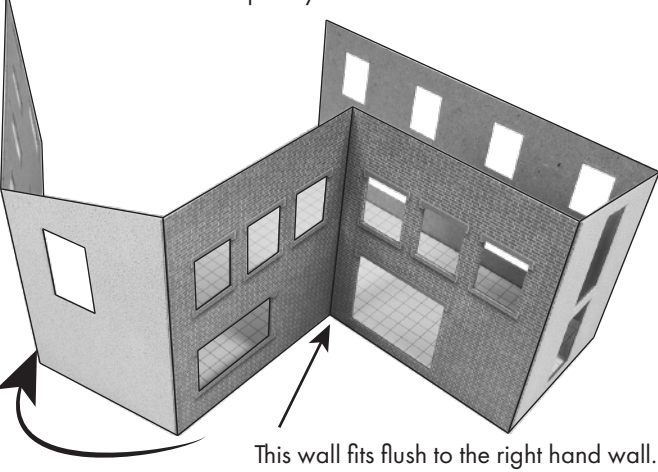

Now add the Lower Wall Support, Lower Front Window Frame, Main Door Frame and Lower Gable Window Frame. Carefully align the windows with the openings, the lower wall support flush to the base.

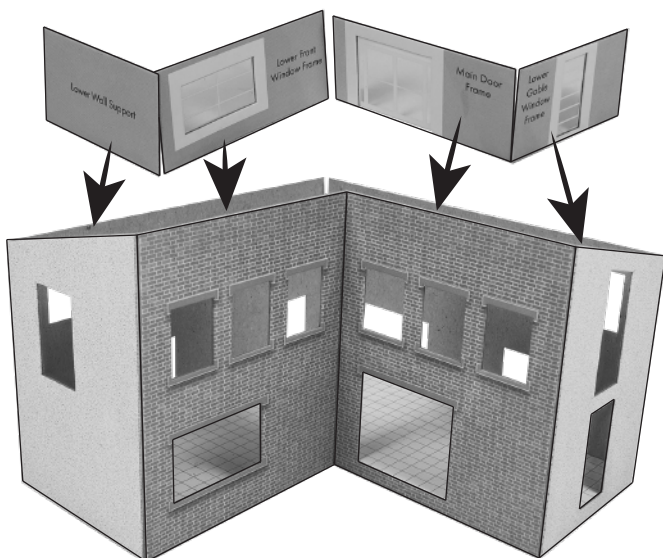

Now the Lower Rear frames 1 and 2.

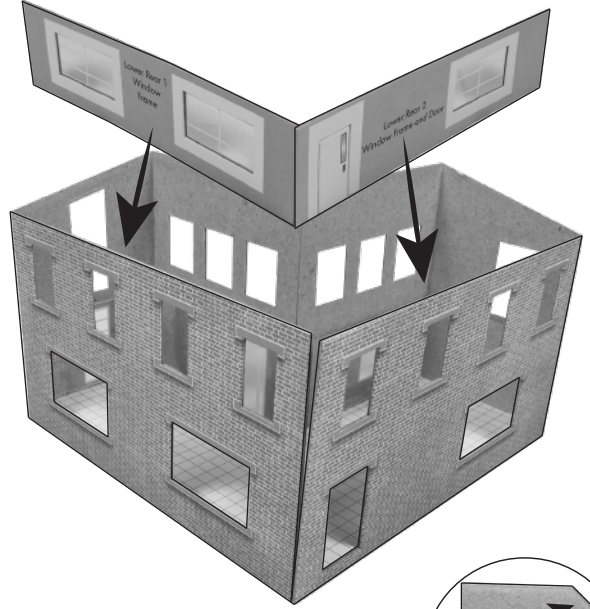

Before placing the S2 floor strengthener into place, it's best to trim the sharp corners of the strengthener to make it easier position it atop the lower frames.

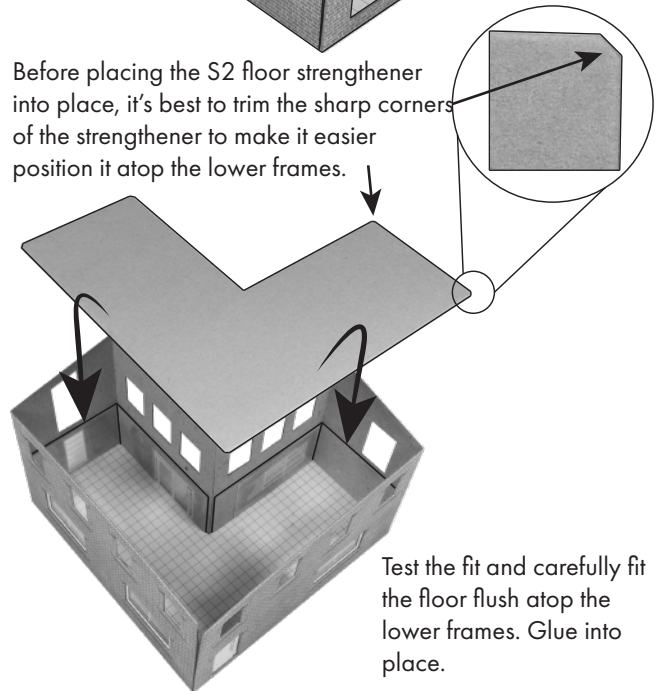

Now add the upper frames, these sit atop the S2 floor, leaving a 1 mm gap from the top of the frames to the top of the outer wall - this is for the S3 roof support to fit into.

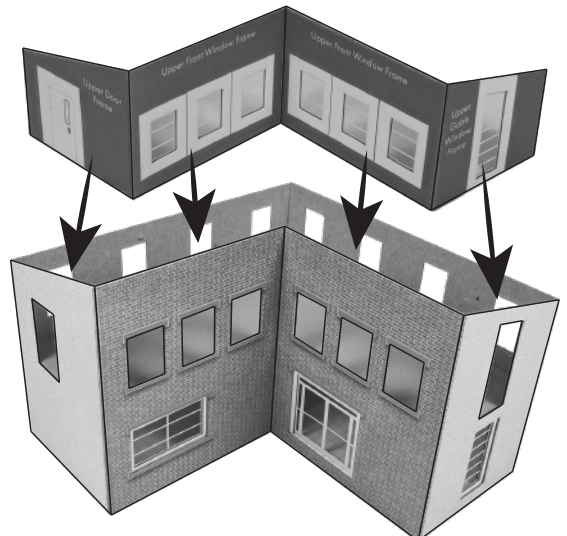



The same with the upper rear frames, again sitting atop the S2 floor, leaving a 1mm gap from the top of the frames to the top of the outer wall for the S3 roof support to fit into.

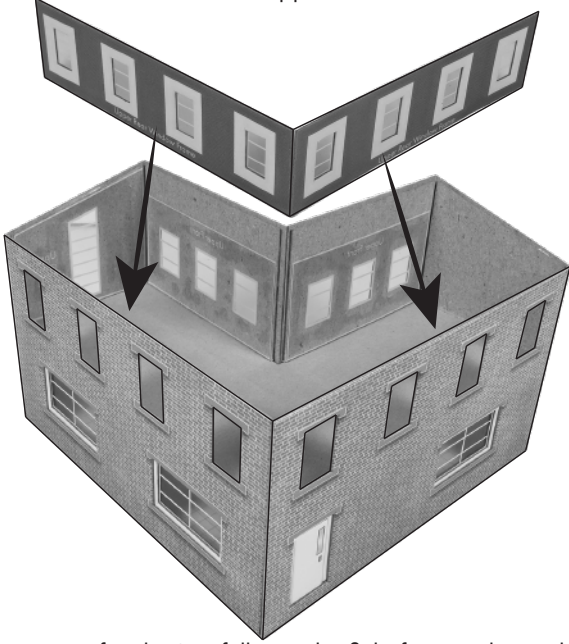

The moment of truth! Carefully test this fit before applying glue, like the S2 floor trim the corners of the S3 Roof support to make the fit easier. Fit the S3 Roof Support atop the upper frames, leaving the support flush with the top edge of the walls.

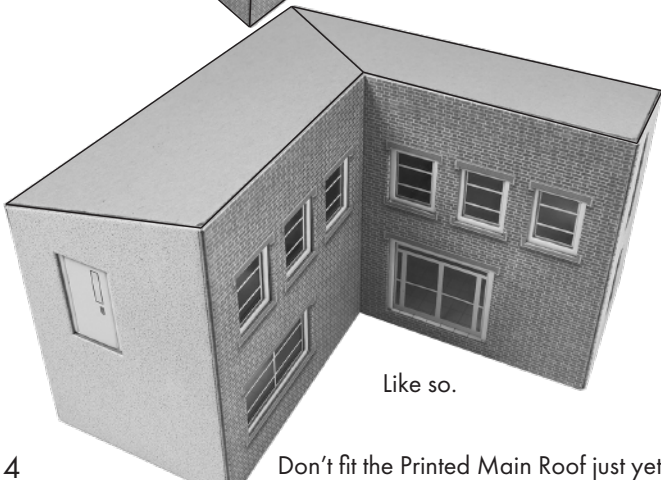
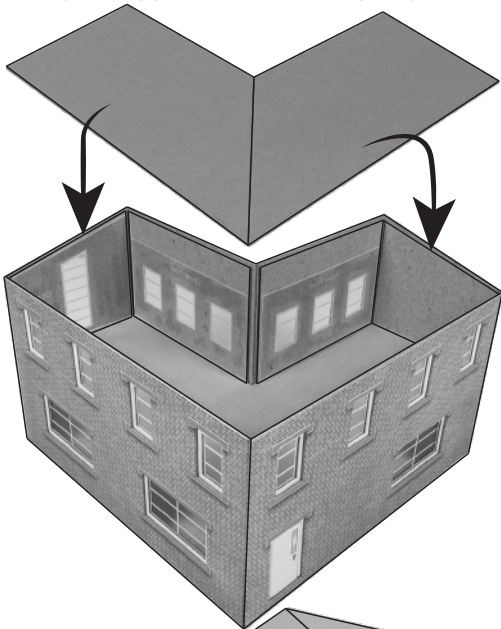

Like so.

Don't fit the Printed Main Roof just yet.

#### 4 Courtyard & Cornerstones

Glue the Courtyard base flush to the building.

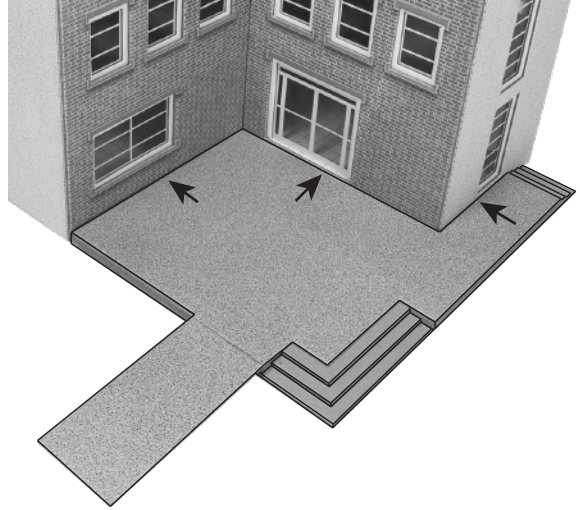

Now for the 5 Main Building Cornerstones. The 2 'half' versions fit to the door end of the building. The full length sides fit to the brickwork the half lengths to the pebble dashed gable end.

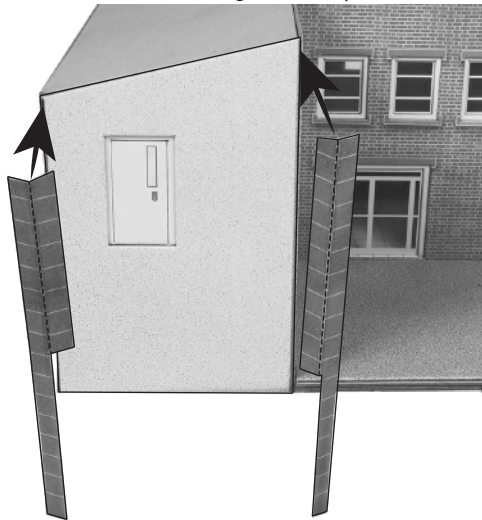

There are 2 corner full stone strips with one end slanted, these fit to the corners of the other gable end following the slope of the roof.



The Cornerstone strip with squared ends fits onto the rear corner, covering the join where the two Main walls meet.

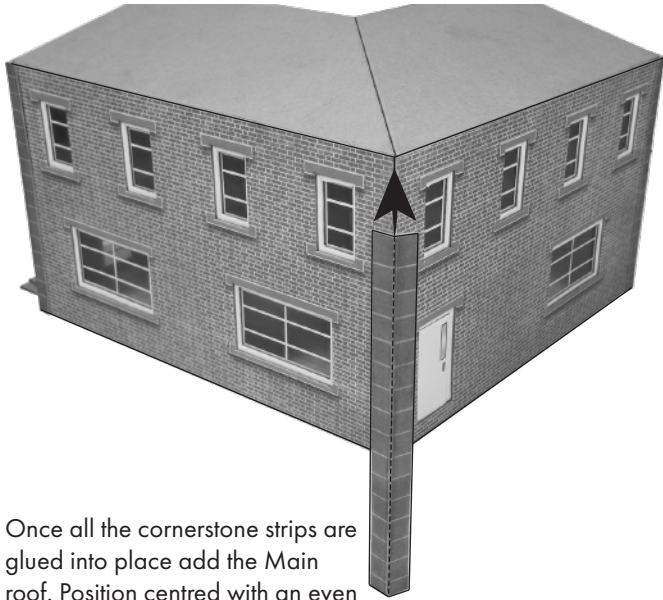

Once all the cornerstone strips are glued into place add the Main roof. Position centred with an even overhang over all sides.

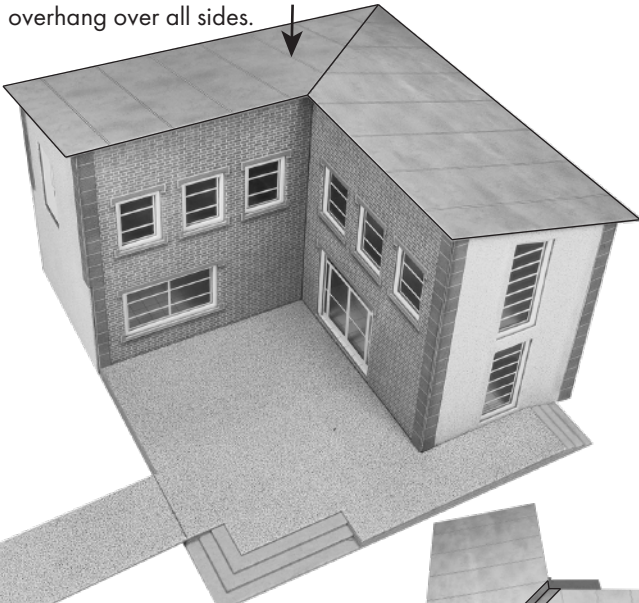

Then add the Roof Ridge Tile

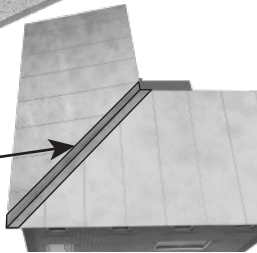

Before moving onto the extension, now is an excellent time to add 2 of the main canopy supports while there is easy access! Start by folding in half and gluing together the Main Canopy Support (from Sheet D)

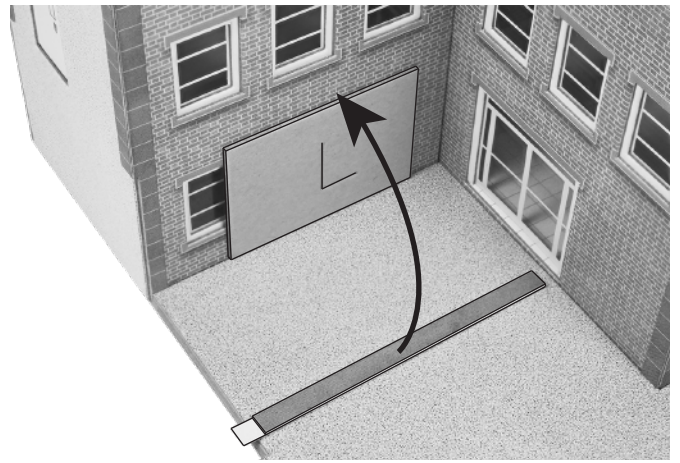
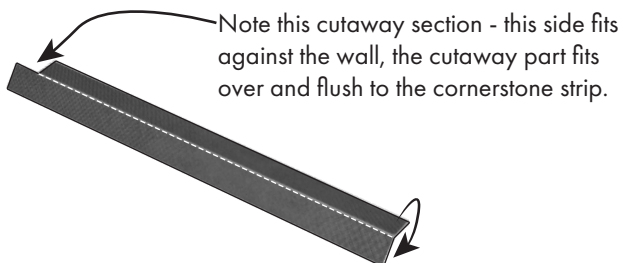

Using the Main Canopy Spacer marked with an "L" (S6) to get the correct height, glue the canopy support to the wall. Be very careful not to get glue on the spacer - you do not want that stuck to the build!



While we're at it we may as well add one of the Main Canopy Side Supports (Sheet C), again use the S6 spacer and fit above the door and flush to the main canopy support. The other side support will have to wait until the extension is complete.

## 5 Extension Building

Start off by wrapping the extension walls around the base.

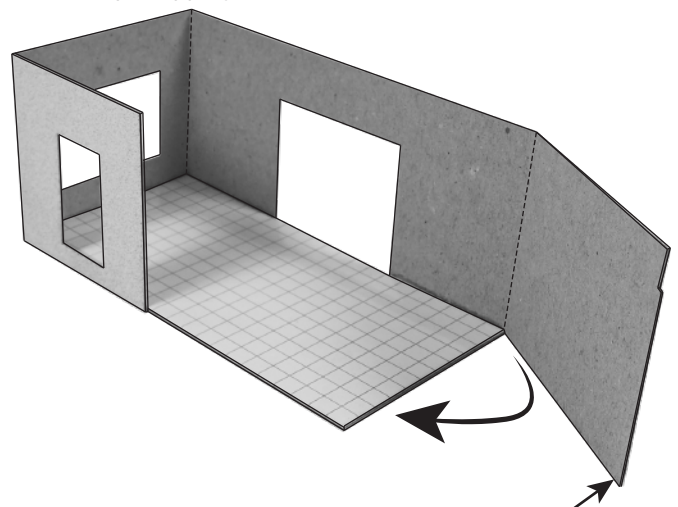

This end wall will be very slightly longer than the base edge.



Now add the doors and window frames along with the wall support. Before adding the courtyard door fold back and glue the top tab to create a double thick edge.

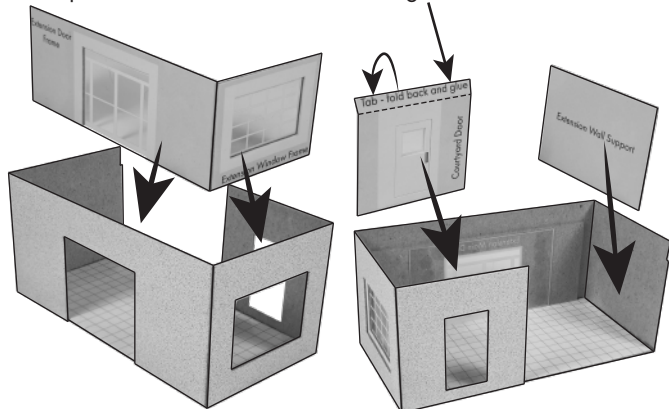

Glue flush to the tops of the inner frames the extension roof.

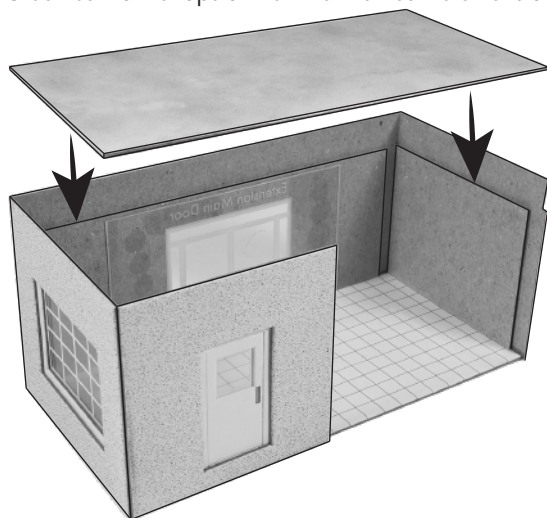

Now the Inner walls. Add the long section first, keeping the top edge flush with the outer wall.

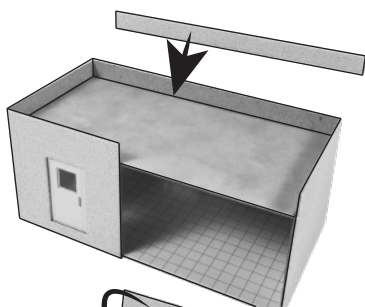

Then the two gable end inner walls.

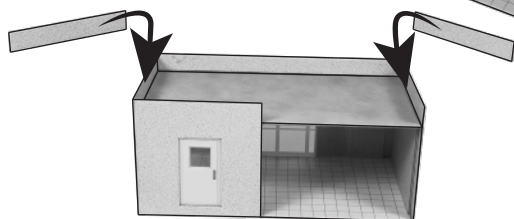

Finally the short inner wall.

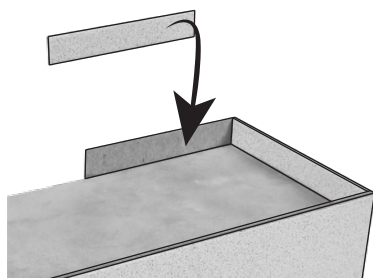

Now add the extension to the main build. Test the fit and take note of the glue points.

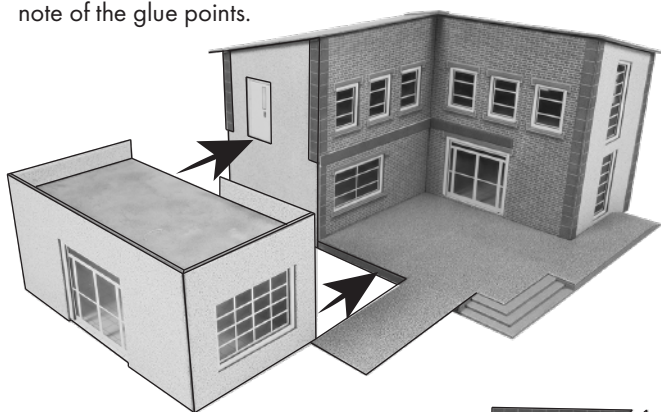

Lay out the Roof wall capping stones as shown. The square ends fit against the main building.

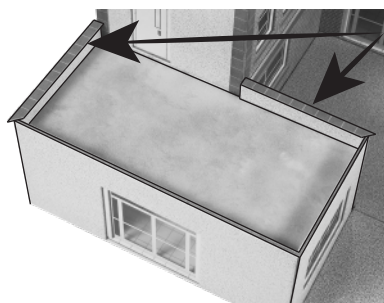
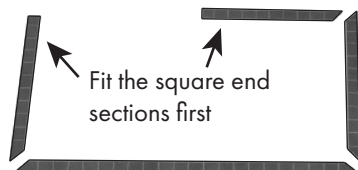

Add the square end sections first, keeping the capping strips centred over the roof wall.

Then add the angled end sections again keeping the strip centred over the wall.

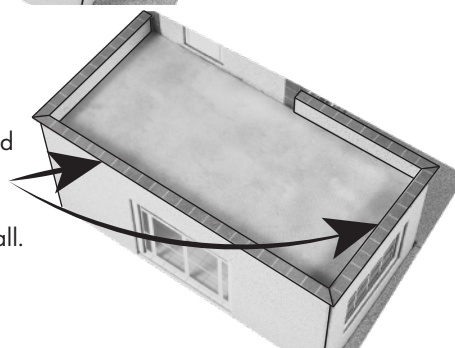

## 6 Canopies

The Main Canopy first.

Add the last Main canopy side support, using the 'L' spacer to get the correct height above the courtyard door.

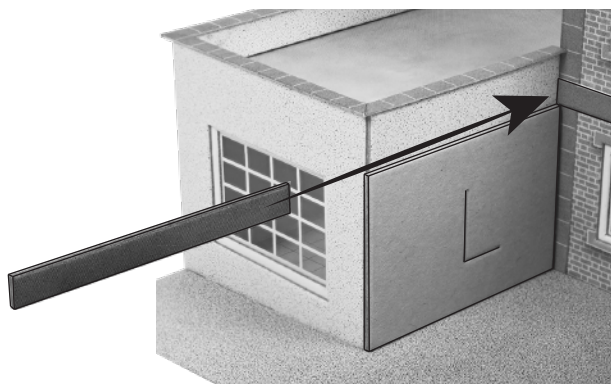

Carefully position the main canopy glazing so that the windows fit the frame. Then fold and glue sandwiching the glazing between the frame.

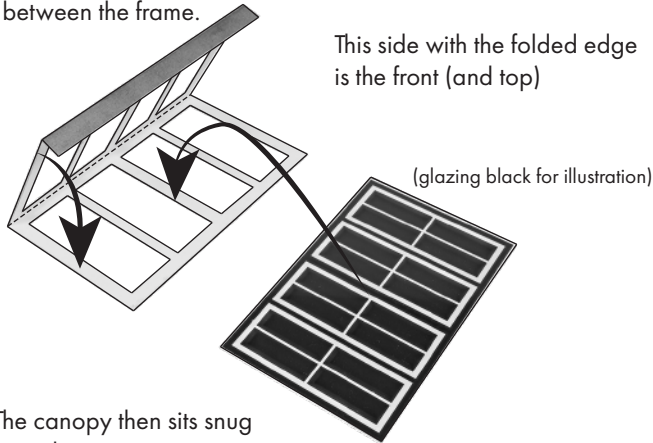

This side with the folded edge is the front (and top)

The canopy then sits snug atop the canopy supports.

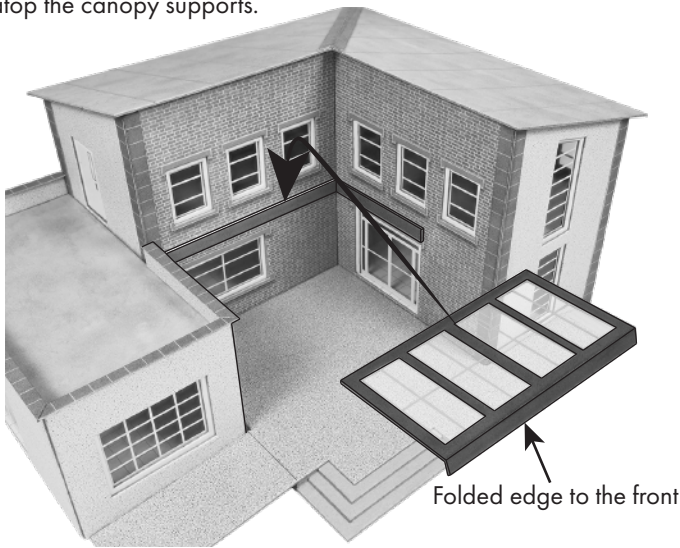

Onto the Side Canopy. Carefully centre the 'T' spacer (S7) to the extension doorway, then carefully glue the side canopy support above the doorway. Take care not to glue the spacer to the wall! Now add the side canopy glazing to the frame.

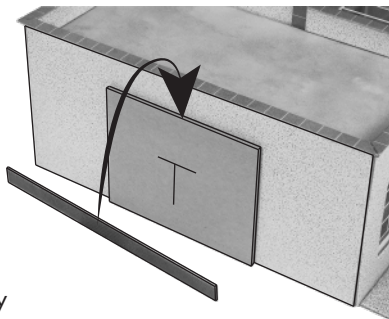

Then fold back to sandwich the glazing.

Fold the side tabs back and glue to get double thickness

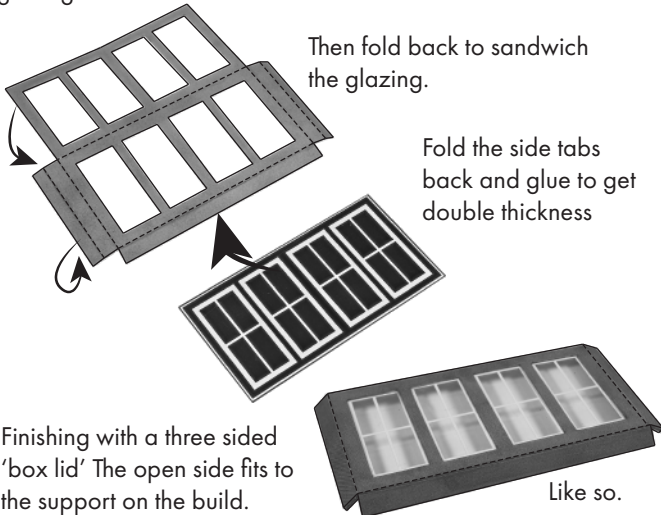

Finishing with a three sided 'box lid' The open side fits to the support on the build.

Then fit the canopy to the support. Use the 'T' spacer (S7) to support the canopy's weight as the glue sets.

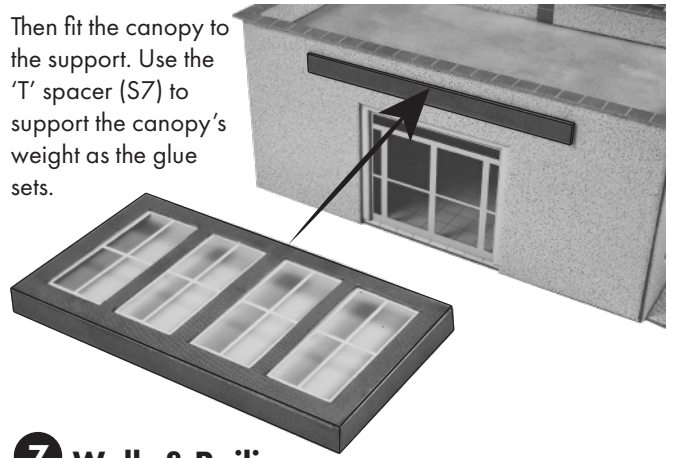

## 7 Walls & Railings

Arrange all the wall parts and the laser cut parts as shown.

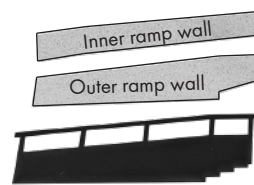
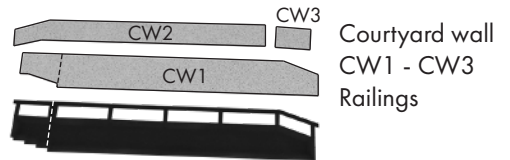

Ramp wall  
Inner, outer  
and railings

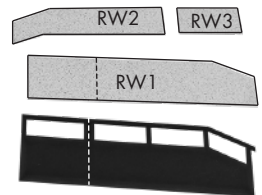

Rear wall  
RW1 - RW3  
and railings

### Courtyard Wall

First, test the scorelines, make sure they fold easily to create a 90 degree corner. Then fit the outer wall CW1 to the laser cut railing keeping the edges flush.

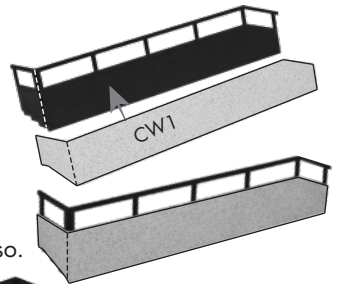

Like so.

Now the inner walls, fit the long wall - CW2 first keeping the top edge flush with the base of the rails.

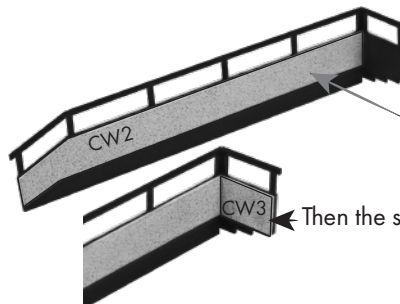

Then the smaller inner wall CW3.

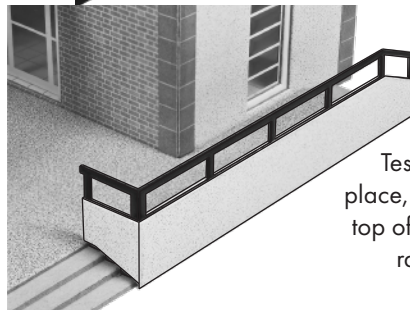

Test the fit first, and glue into place, the inner walls resting on top of the main base, the black railing fitting into the steps.



### Ramp Wall

Add the inner and outer walls to the railing, keeping the edges flush with the base of the railings.

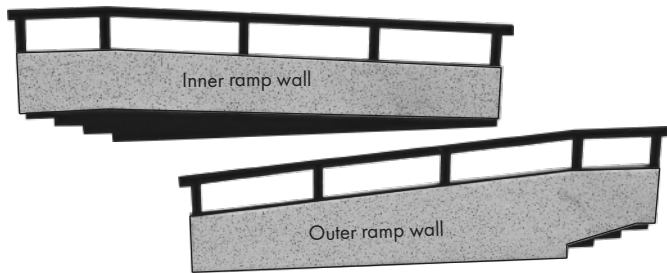

Then add to the base, fix the ramp flush up to the base of the inner wall.

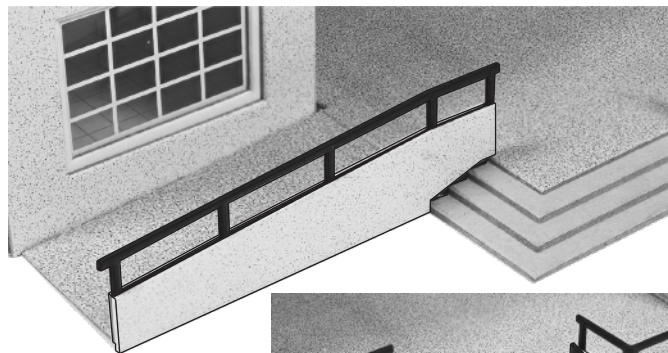

Add the two handrails to complete the main steps.

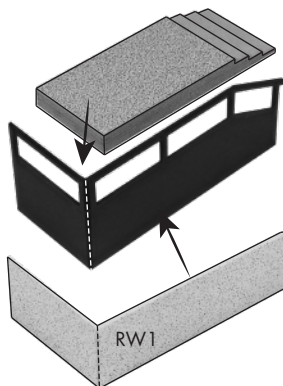
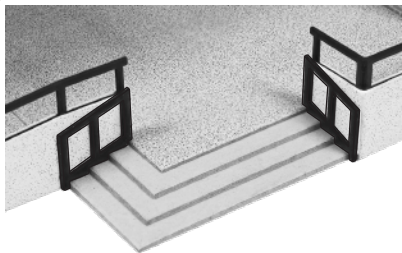

### Rear Wall

Add the outer wall RW1 to the railing, keeping the edges flush with the base of the railings, then add to the rear steps.

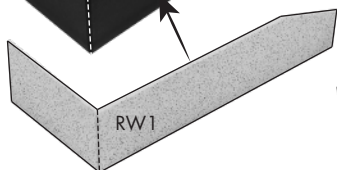

Like so.

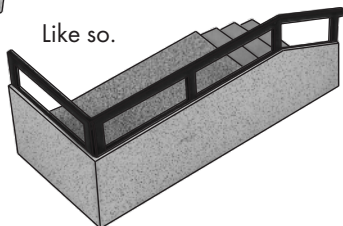

Next add the inner walls, RW2 first, then the smaller RW3.

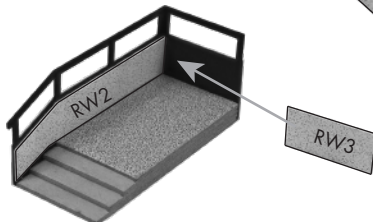

Then fix in position to the rear door.

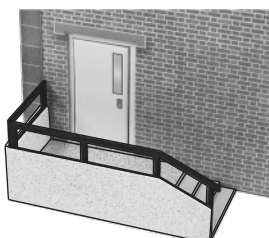

## 8 Final Touches

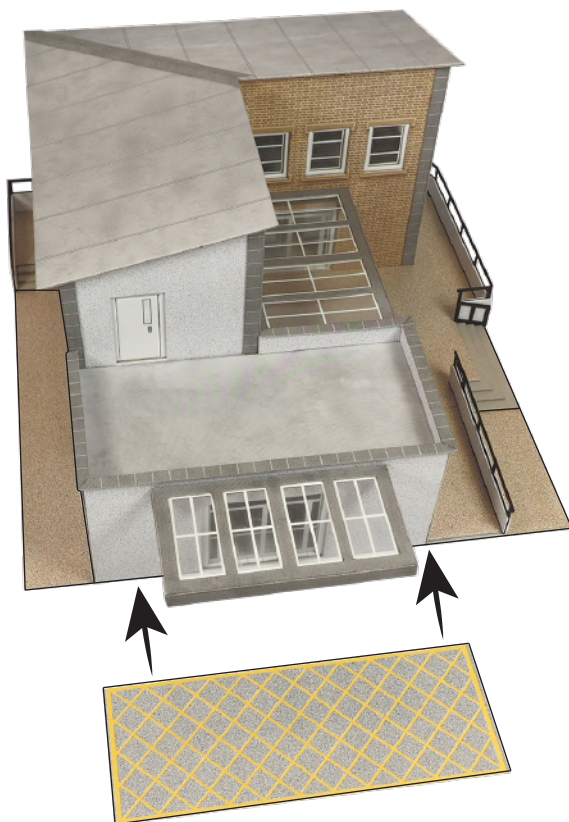

Carefully position the whole build onto the Main Base, adding the 'No Stopping' tarmac to the extension door (if required)

Finish by adding signs of your choice.

